



Ürün Kodu

Product Code

DP2 SAL1K3

Araç Tipi Vehicle Type	MERCEDES	MAN	BMC	FORD	IVECO	DAF	RENAULT
	DODGE	VOLVO					

Şanzıman Tipi Gearbox Type	ZF 44	ZF 6 S 800	ZF 6 S 1000	ZF S 6 35	ZF S 6 42	ZF S 6 50	ZF 9 S 109
	ZF S 6 55	ZF S 6 65	ZF S 6 70	ZF S 6 75	ZF S 6 80	ZF S 6 90	ZF 16 S 109
	ZF S 5 50	ZF S 5 90	ZF 16 S 251	ZF 16 S 221	ZF 16 S 151	ZF 16 S 150	ZF AK 6 80
	ZF 16 S 130	ZF 6 S 120	ZF 6 S 111	ZF 6 S 110	ZF 6 S 92	ZF 9 S 75	ZF AK 6 90
	GV 90	2855					

Montaj Şekli Mounting Side	Kontrol Tipi Control Type	Dönüş Yönü Rotation Sense	Çevrim Oranı Ratio	Ağırlık Weight	Güç Power	Maksimum Tork Maximum Torque	
				Kg	KW	Nm	Kgm
KUYRUK	HAVALI	SOL (SAAT YÖNÜ TERSİ)	1/1,28	12	50	490	50
REAR	PNEUMATIC	LEFT (COUNTERCLOCKWISE)					

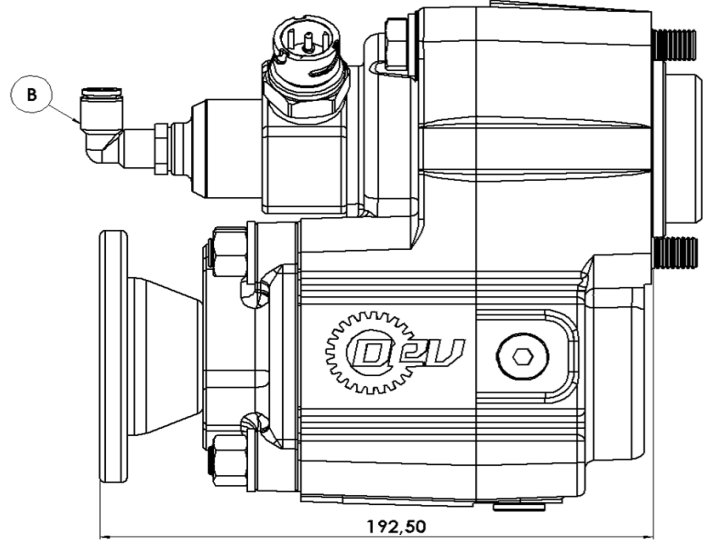
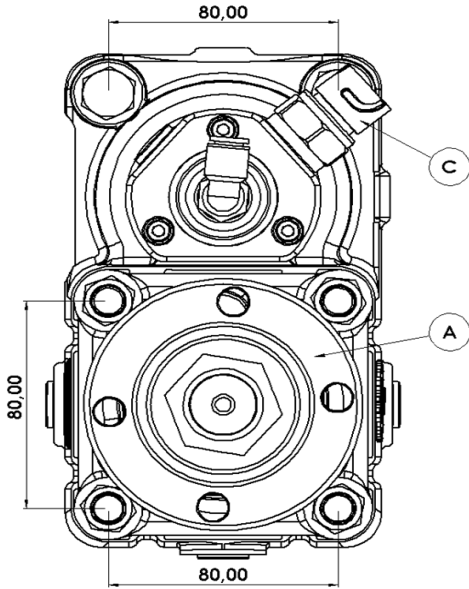

PTO ÖZELLİKLERİ PTO PROPERTIES	A		B		C		AÇIKLAMA
	PTO Çıkış	PTO Output	Hava Girişi	Air Intel	Elektrik Müşürü	Electrical Switche	
	4 Delik Flanş		R 1/4"		12V		
	4 Hole Flange		R 1/4"		12V		

Phone : +90 212 647 7700

Email : info@devmatek.com

Address : Ömerli Mah. Mısır Sk. No:5 Arnavutköy/İstanbul

Mobile : +90 552 670 6056

Web : www.devmatek.com